

BC856ALT1 Series

Preferred Devices

General Purpose Transistors

PNP Silicon

Features

- Pb-Free Packages are Available

MAXIMUM RATINGS ($T_A = 25^\circ\text{C}$ unless otherwise noted)

| Rating | Symbol | Value | Unit |
|---|-----------|-------------------|------|
| Collector-Emitter Voltage BC856 BC857 BC858, BC859 | V_{CEO} | -65 -45 -30 | V |
| Collector-Base Voltage BC856 BC857 BC858, BC859 | V_{CBO} | -80 -50 -30 | V |
| Emitter-Base Voltage | V_{EBO} | -5.0 | V |
| Collector Current – Continuous | I_C | -100 | mAdc |

Maximum ratings are those values beyond which device damage can occur. Maximum ratings applied to the device are individual stress limit values (not normal operating conditions) and are not valid simultaneously. If these limits are exceeded, device functional operation is not implied, damage may occur and reliability may be affected.

THERMAL CHARACTERISTICS

| Characteristic | Symbol | Max | Unit |
|---|-----------------|----------------|----------------------------|
| Total Device Dissipation FR-5 Board, (Note 1) $T_A = 25^\circ\text{C}$ Derate above 25°C | P_D | 225 1.8 | mW mW/ $^\circ\text{C}$ |
| Thermal Resistance, Junction-to-Ambient | $R_{\theta JA}$ | 556 | $^\circ\text{C}/\text{W}$ |
| Total Device Dissipation Alumina Substrate, (Note 2) $T_A = 25^\circ\text{C}$ Derate above 25°C | P_D | 300 2.4 | mW mW/ $^\circ\text{C}$ |
| Thermal Resistance, Junction-to-Ambient | $R_{\theta JA}$ | 417 | $^\circ\text{C}/\text{W}$ |
| Junction and Storage Temperature | T_J, T_{stg} | -55 to +150 | $^\circ\text{C}$ |

- FR-5 = 1.0 x 0.75 x 0.062 in.
- Alumina = 0.4 x 0.3 x 0.024 in 99.5% alumina.



ON Semiconductor®

<http://onsemi.com>

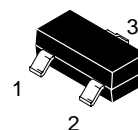
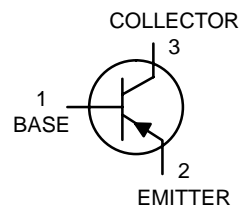

SOT-23
CASE 318
STYLE 6

MARKING DIAGRAM

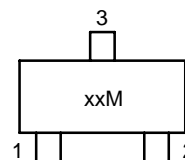

xx = Device Code
M = Date Code

ORDERING INFORMATION

See detailed ordering and shipping information in the package dimensions section on page 6 of this data sheet.

Preferred devices are recommended choices for future use and best overall value.

BC856ALT1 Series

ELECTRICAL CHARACTERISTICS (T_A = 25°C unless otherwise noted)

| Characteristic | Symbol | Min | Typ | Max | Unit |
|---|--|----------------------|----------------------|-------------------|-------------------|
| OFF CHARACTERISTICS | | | | | |
| Collector–Emitter Breakdown Voltage (I _C = –10 mA) | BC856 Series BC857 Series BC858, BC859 Series | V _{(BR)CEO} | –65 –45 –30 | – – – | V |
| Collector–Emitter Breakdown Voltage (I _C = –10 μA, V _{EB} = 0) | BC856 Series BC857A, BC857B Only BC858, BC859 Series | V _{(BR)CES} | –80 –50 –30 | – – – | V |
| Collector–Base Breakdown Voltage (I _C = –10 μA) | BC856 Series BC857 Series BC858, BC859 Series | V _{(BR)CBO} | –80 –50 –30 | – – – | V |
| Emitter–Base Breakdown Voltage (I _E = –1.0 μA) | BC856 Series BC857 Series BC858, BC859 Series | V _{(BR)EBO} | –5.0 –5.0 –5.0 | – – – | V |
| Collector Cutoff Current (V _{CB} = –30 V) (V _{CB} = –30 V, T _A = 150°C) | | I _{CBO} | – – | – – | nA μA |
| ON CHARACTERISTICS | | | | | |
| DC Current Gain (I _C = –10 μA, V _{CE} = –5.0 V) | BC856A, BC857A, BC858A BC856B, BC857B, BC858B BC857C, BC858C | h _{FE} | – – – | 90 150 270 | – |
| (I _C = –2.0 mA, V _{CE} = –5.0 V) | BC856A, BC857A, BC858A BC856B, BC857B, BC858B, BC859B BC857C, BC858C, BC859C | | 125 220 420 | 180 290 520 | 250 475 800 |
| Collector–Emitter Saturation Voltage (I _C = –10 mA, I _B = –0.5 mA) (I _C = –100 mA, I _B = –5.0 mA) | | V _{CE(sat)} | – – | – – | –0.3 –0.65 |
| Base–Emitter Saturation Voltage (I _C = –10 mA, I _B = –0.5 mA) (I _C = –100 mA, I _B = –5.0 mA) | | V _{BE(sat)} | – – | –0.7 –0.9 | – – |
| Base–Emitter On Voltage (I _C = –2.0 mA, V _{CE} = –5.0 V) (I _C = –10 mA, V _{CE} = –5.0 V) | | V _{BE(on)} | –0.6 – | – – | –0.75 –0.82 |
| SMALL–SIGNAL CHARACTERISTICS | | | | | |
| Current–Gain – Bandwidth Product (I _C = –10 mA, V _{CE} = –5.0 Vdc, f = 100 MHz) | | f _T | 100 | – | – |
| Output Capacitance (V _{CB} = –10 V, f = 1.0 MHz) | | C _{ob} | – | – | 4.5 |
| Noise Figure (I _C = –0.2 mA, V _{CE} = –5.0 Vdc, R _S = 2.0 kΩ, f = 1.0 kHz, BW = 200 Hz) | BC856, BC857, BC858 Series BC859 Series | NF | – – | – – | 10 4.0 |

BC856ALT1 Series

BC857/BC858/BC859

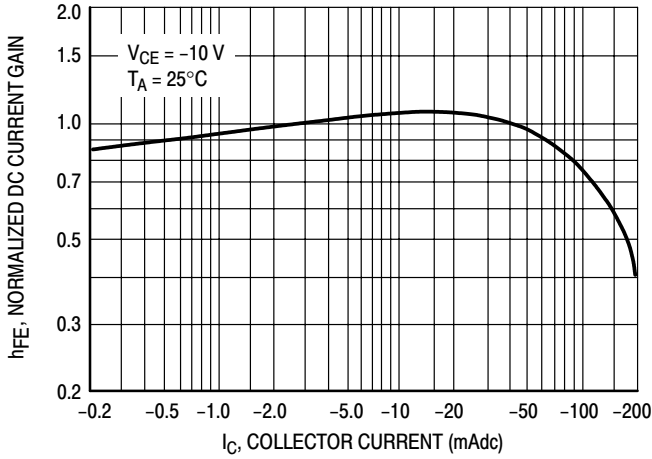

Figure 1. Normalized DC Current Gain

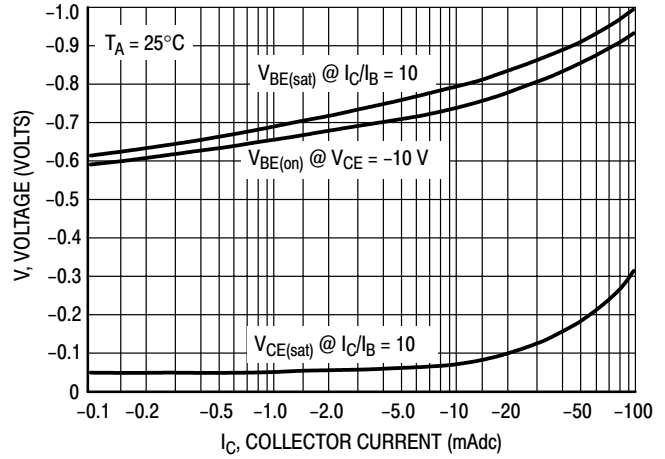

Figure 2. "Saturation" and "On" Voltages

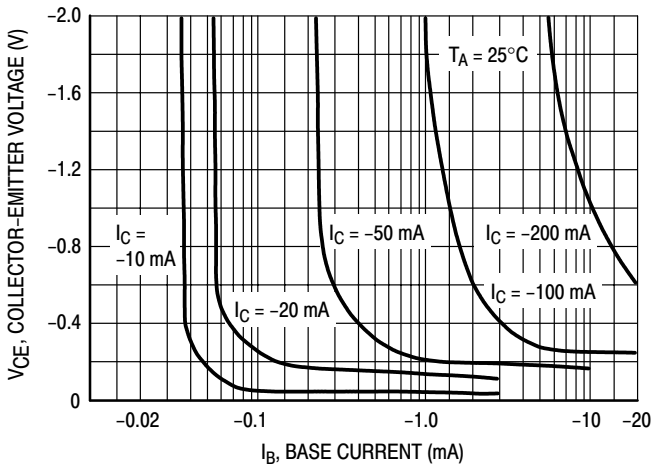

Figure 3. Collector Saturation Region

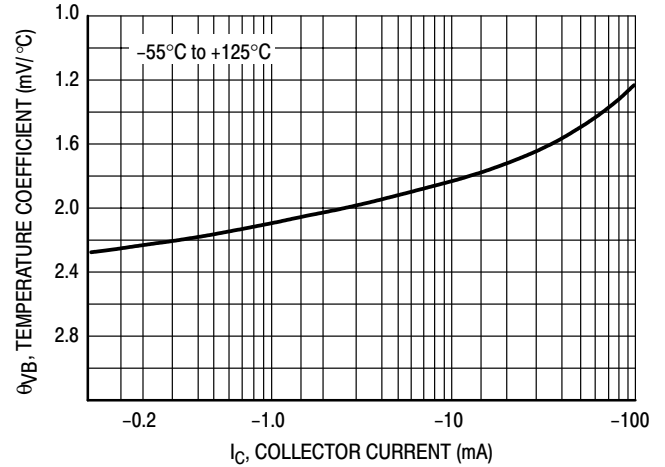

Figure 4. Base-Emitter Temperature Coefficient

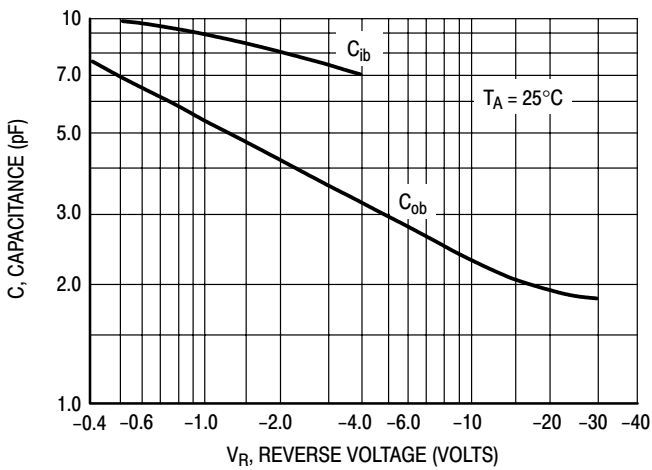

Figure 5. Capacitances

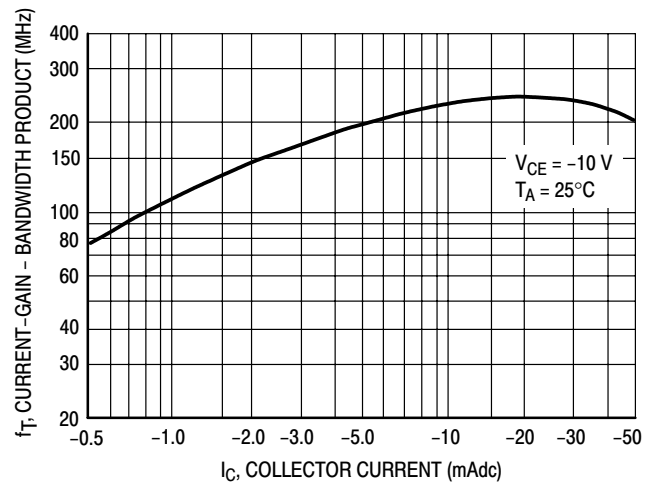

Figure 6. Current-Gain - Bandwidth Product

BC856ALT1 Series

BC856

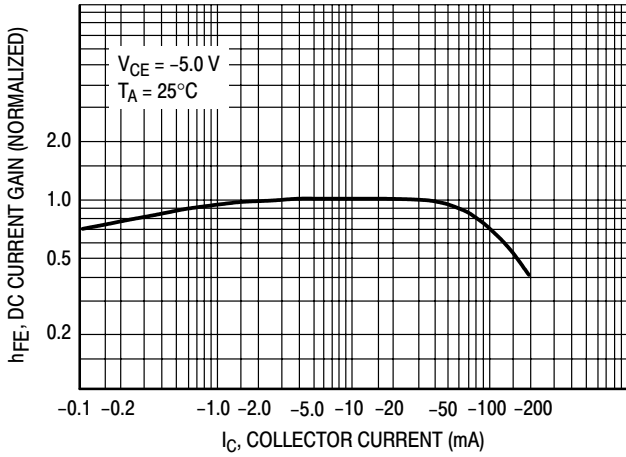

Figure 7. DC Current Gain

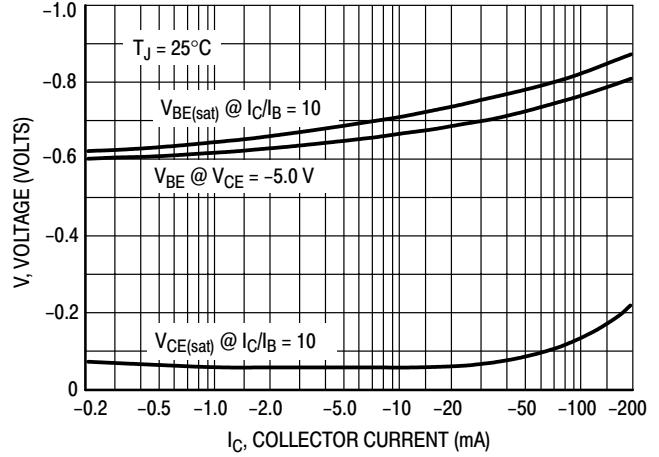

Figure 8. "On" Voltage

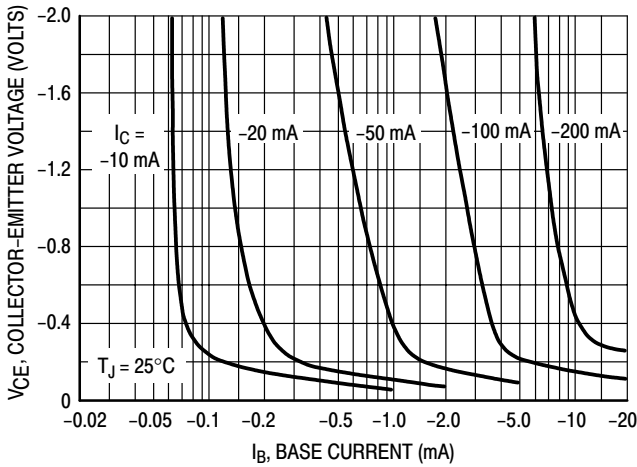

Figure 9. Collector Saturation Region

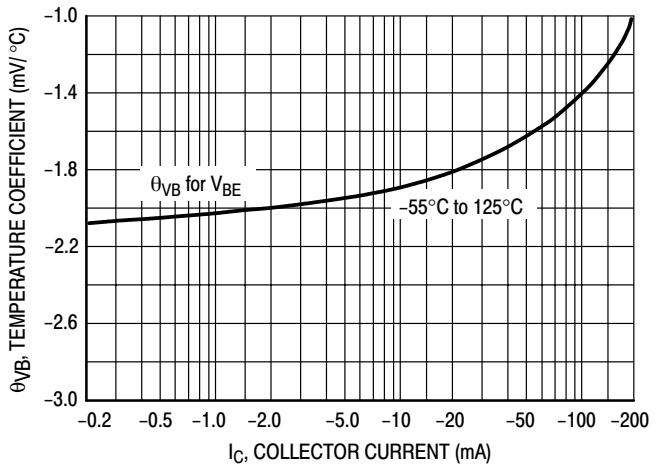

Figure 10. Base-Emitter Temperature Coefficient

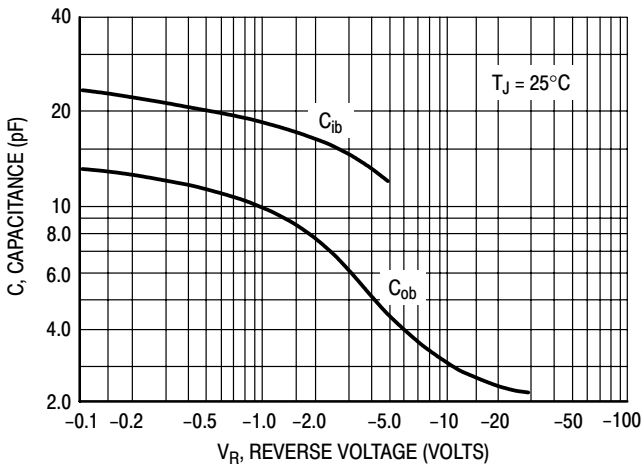

Figure 11. Capacitance

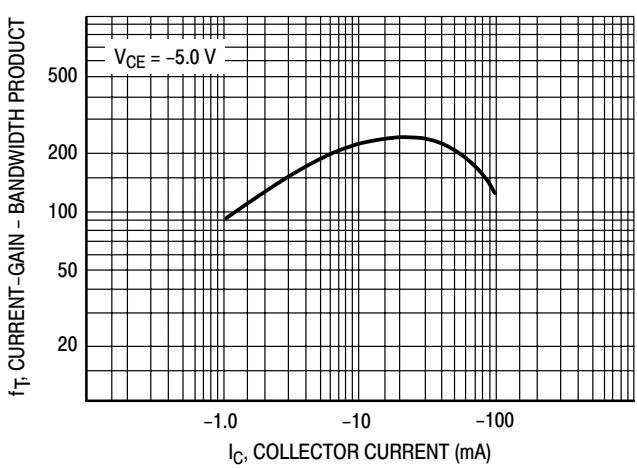

Figure 12. Current-Gain - Bandwidth Product

BC856ALT1 Series

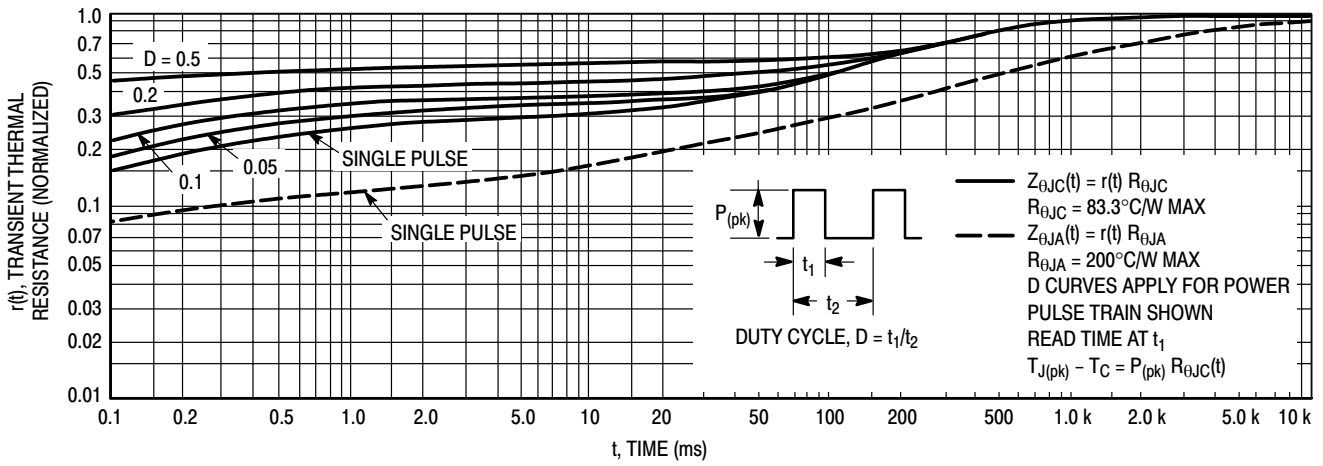

Figure 13. Thermal Response

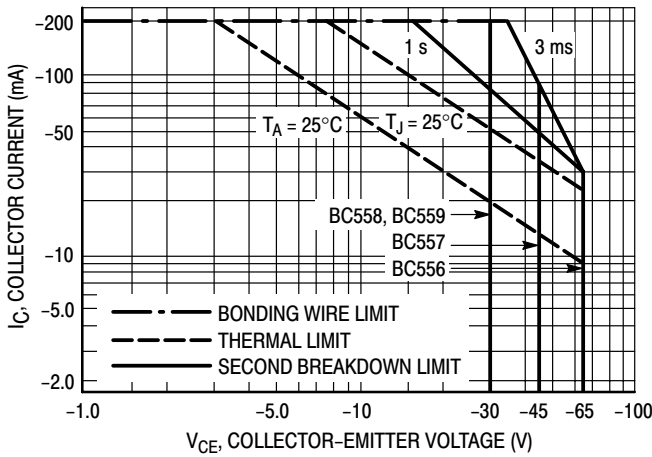

Figure 14. Active Region Safe Operating Area

The safe operating area curves indicate I_C - V_{CE} limits of the transistor that must be observed for reliable operation. Collector load lines for specific circuits must fall below the limits indicated by the applicable curve.

The data of Figure 14 is based upon $T_{J(pk)} = 150^{\circ}C$; T_C or T_A is variable depending upon conditions. Pulse curves are valid for duty cycles to 10% provided $T_{J(pk)} \leq 150^{\circ}C$. $T_{J(pk)}$ may be calculated from the data in Figure 13. At high case or ambient temperatures, thermal limitations will reduce the power that can be handled to values less than the limitations imposed by the secondary breakdown.

BC856ALT1 Series

ORDERING INFORMATION

| Device | Marking | Package | Shipping† |
|------------|---------|---------------------|----------------------|
| BC856ALT1 | 3A | SOT-23 | 3,000 / Tape & Reel |
| BC856ALT3 | 3A | SOT-23 | 10,000 / Tape & Reel |
| BC856BLT1 | 3B | SOT-23 | 3,000 / Tape & Reel |
| BC856BLT1G | 3B | SOT-23 (Pb-Free) | |
| BC856BLT3 | 3B | SOT-23 | 10,000 / Tape & Reel |
| BC857ALT1 | 3E | SOT-23 | 3,000 / Tape & Reel |
| BC857BLT1 | 3F | SOT-23 | 3,000 / Tape & Reel |
| BC857BLT3 | 3F | SOT-23 | 10,000 / Tape & Reel |
| BC857BLT3G | 3F | SOT-23 (Pb-Free) | |
| BC857CLT1 | 3G | SOT-23 | 3,000 / Tape & Reel |
| BC857CLT1G | 3G | SOT-23 (Pb-Free) | 3,000 / Tape & Reel |
| BC858ALT1 | 3J | SOT-23 | 3,000 / Tape & Reel |
| BC858ALT1G | 3J | SOT-23 (Pb-Free) | |
| BC858BLT1 | 3K | SOT-23 | 3,000 / Tape & Reel |
| BC858BLT1G | 3K | SOT-23 (Pb-Free) | |
| BC858BLT3 | 3L | SOT-23 | 10,000 / Tape & Reel |
| BC858CLT1 | 3L | SOT-23 | 3,000 / Tape & Reel |
| BC858CLT1G | 3L | SOT-23 (Pb-Free) | |
| BC858CLT3 | 3L | SOT-23 | 10,000 / Tape & Reel |
| BC858CLT3G | 3L | SOT-23 (Pb-Free) | |
| BC859BLT1 | 4B | SOT-23 | 3,000 / Tape & Reel |
| BC859BLT3 | 4B | SOT-23 | 10,000 / Tape & Reel |
| BC859CLT1 | 4C | SOT-23 | 3,000 / Tape & Reel |
| BC859CLT3 | 4C | SOT-23 | 10,000 / Tape & Reel |

†For information on tape and reel specifications, including part orientation and tape sizes, please refer to our Tape and Reel Packaging Specifications Brochure, BRD8011/D.

BC856ALT1 Series

PACKAGE DIMENSIONS

SOT-23 (TO-236)
CASE 318-09
ISSUE AI

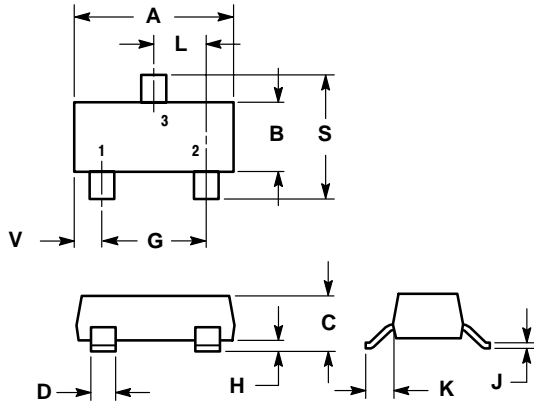

- NOTES:
1. DIMENSIONING AND TOLERANCING PER ANSI Y14.5M, 1982.
 2. CONTROLLING DIMENSION: INCH.
 3. MAXIMUM LEAD THICKNESS INCLUDES LEAD FINISH THICKNESS. MINIMUM LEAD THICKNESS IS THE MINIMUM THICKNESS OF BASE MATERIAL.
 4. 318-01, -02, AND -06 OBSOLETE, NEW STANDARD 318-09.

| DIM | INCHES | | MILLIMETERS | |
|-----|--------|--------|-------------|-------|
| | MIN | MAX | MIN | MAX |
| A | 0.1102 | 0.1197 | 2.80 | 3.04 |
| B | 0.0472 | 0.0551 | 1.20 | 1.40 |
| C | 0.0385 | 0.0498 | 0.99 | 1.26 |
| D | 0.0140 | 0.0200 | 0.36 | 0.50 |
| G | 0.0670 | 0.0826 | 1.70 | 2.10 |
| H | 0.0040 | 0.0098 | 0.10 | 0.25 |
| J | 0.0034 | 0.0070 | 0.085 | 0.177 |
| K | 0.0180 | 0.0236 | 0.45 | 0.60 |
| L | 0.0350 | 0.0401 | 0.89 | 1.02 |
| S | 0.0830 | 0.0984 | 2.10 | 2.50 |
| V | 0.0177 | 0.0236 | 0.45 | 0.60 |

- STYLE 6:
PIN 1. BASE
2. EMITTER
3. COLLECTOR

SOLDERING FOOTPRINT*

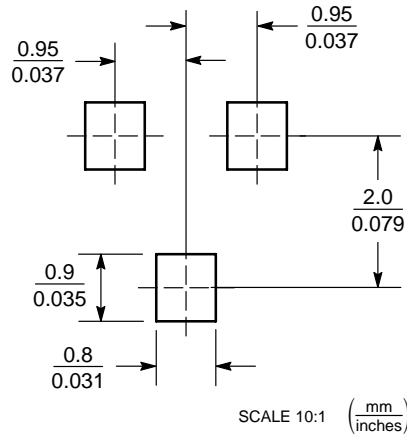

*For additional information on our Pb-Free strategy and soldering details, please download the ON Semiconductor Soldering and Mounting Techniques Reference Manual, SOLDERRM/D.

BC856ALT1 Series

ON Semiconductor and  are registered trademarks of Semiconductor Components Industries, LLC (SCILLC). SCILLC reserves the right to make changes without further notice to any products herein. SCILLC makes no warranty, representation or guarantee regarding the suitability of its products for any particular purpose, nor does SCILLC assume any liability arising out of the application or use of any product or circuit, and specifically disclaims any and all liability, including without limitation special, consequential or incidental damages. "Typical" parameters which may be provided in SCILLC data sheets and/or specifications can and do vary in different applications and actual performance may vary over time. All operating parameters, including "Typicals" must be validated for each customer application by customer's technical experts. SCILLC does not convey any license under its patent rights nor the rights of others. SCILLC products are not designed, intended, or authorized for use as components in systems intended for surgical implant into the body, or other applications intended to support or sustain life, or for any other application in which the failure of the SCILLC product could create a situation where personal injury or death may occur. Should Buyer purchase or use SCILLC products for any such unintended or unauthorized application, Buyer shall indemnify and hold SCILLC and its officers, employees, subsidiaries, affiliates, and distributors harmless against all claims, costs, damages, and expenses, and reasonable attorney fees arising out of, directly or indirectly, any claim of personal injury or death associated with such unintended or unauthorized use, even if such claim alleges that SCILLC was negligent regarding the design or manufacture of the part. SCILLC is an Equal Opportunity/Affirmative Action Employer. This literature is subject to all applicable copyright laws and is not for resale in any manner.

PUBLICATION ORDERING INFORMATION

LITERATURE FULFILLMENT:

Literature Distribution Center for ON Semiconductor
P.O. Box 61312, Phoenix, Arizona 85082-1312 USA
Phone: 480-829-7710 or 800-344-3860 Toll Free USA/Canada
Fax: 480-829-7709 or 800-344-3867 Toll Free USA/Canada
Email: orderlit@onsemi.com

N. American Technical Support: 800-282-9855 Toll Free
USA/Canada

Japan: ON Semiconductor, Japan Customer Focus Center
2-9-1 Kamimeguro, Meguro-ku, Tokyo, Japan 153-0051
Phone: 81-3-5773-3850

ON Semiconductor Website: <http://onsemi.com>

Order Literature: <http://www.onsemi.com/litorder>

For additional information, please contact your
local Sales Representative.